

LETO 44 WM LRG

WALL MOUNT LED DOWNLIGHT

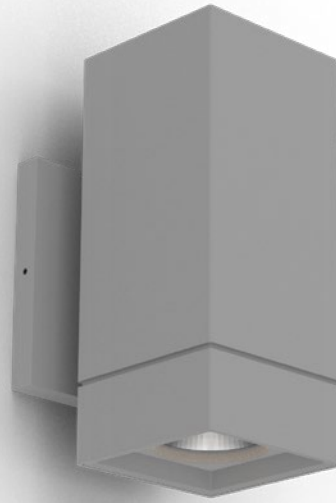

Leto 44 WM LRG - Wall Mount LED Light. Leto 44 WM LRG is a wall mounted cylinder LED fixture designed to provide a space with indirect lighting. It is the perfect solution for creating subtle light in your space.

Ordering Code

Fixture	719							
	1	2	3	4	5	6	7	8
Driver				--	--			
	1	2	3	4	5			

Product Specifications

SAMPLE: Fixture 719 - A90 - 615 - 27 - 07 - DL - 08 - 02 | Driver 910 - STD - 120 - A90 - 07

1 - Model	2 - LED	3 - Optic		4 - CCT	5 - Lumen	6 - Accessory
719 · Leto 44 Large Wall Mount	A90 · 93+ CRI Accuracy	<i>Faceted</i> 615 · 15° 630 · 30° 645 · 45° 660 · 60°	<i>Smooth</i> 630S · 30° 645S · 45°	25 · 2500K 27 · 2700K 30 · 3000K 35 · 3500K 40 · 4000K 65 · 6500K	07 · 700 (6.1W) 10 · 1000 (9.1W) 15 · 1500 (14W) 20 · 2000 (19.8W)	00 · No Accessory DL · Diffusing Lens HO · Honeycomb SL · Solite Lens

7 - Body Color		8 - Baffle Color		1 - Housing	2 - Driver	Dim Level	Dim Level
<i>Standard</i> 01 · White 02 · Black 08 · Silver	<i>Premium</i> 52 · Mocha 53 · Charcoal 54 · Cerulean 55 · Firebrick XX · RAL	<i>Standard</i> 01 · White 02 · Black 08 · Silver	<i>Premium</i> 52 · Mocha 53 · Charcoal 54 · Cerulean 55 · Firebrick XX · RAL	00 · Integral Driver 910 · Remote Driver Housing	STD · Non Dimming LCS · 0 - 10 Volt Protocol DIM · Phase*1 ELDOLC · EldoLED 0 - 10 Volt*2 DALI · Dali Protocol*2	N/A 1% 1% 0.1% 0.1%	LUTES · Hilume Ecodigital*2 1% LUT2W · 2 Wire for phase*1/2 1% DMX · SENSO*2 EMG · Emergency Driver*2/3 CSMB · Casambi Wireless Control*2/3

3 - Voltage	4 - LED	5 - Lumen
120 · 120V 277 · 277V 347 · 347V*2/4	Same as Fixture	Same as Fixture

*1 120V only
*2 remote mount
*3 second driver required
*4 not available with ELDO, Lutron or DMX

LETO 44 WM LRG

WALL MOUNT LED DOWNLIGHT

Reflector

SENSO metal spun faceted reflectors are specifically designed to retain as much light as possible. This results in a more power efficient fixture with a higher delivered lumen.

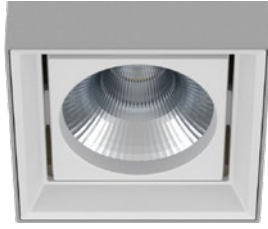

Installation

- Mounting plate included
- Easy, single motion installation method

Construction / Finish

- High quality, scratch resistant powder coated finish in standard, premium or custom colors
- Aluminum extruded Body
- Made in Canada

Dimensions

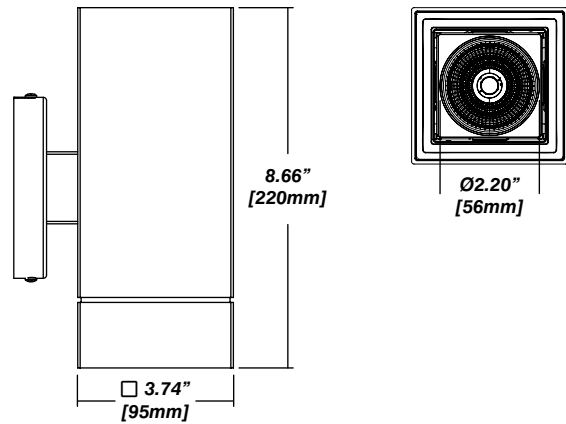

Accessories

Diffusing Lens

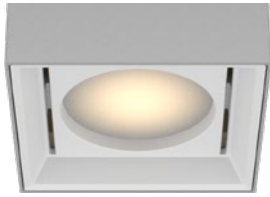

Honeycomb Mesh

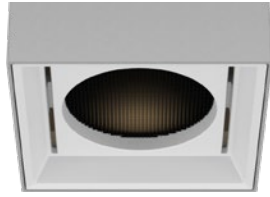

Solite Lens

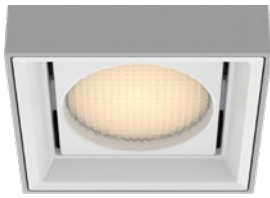

Senso Driver Housings

Single Remote Driver Housing

- Fits Standard, LCS or DIM drivers
- Galvanized steel enclosure
- For remote driver applications

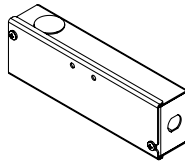

Dimensions

1.5"
[39mm]

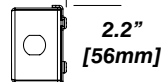

7.0"
[177mm]



Double Remote Driver Housing

- Fits all drivers
- Galvanized steel enclosure
- For remote driver applications

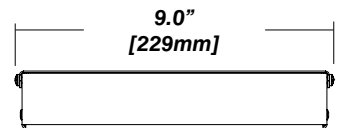
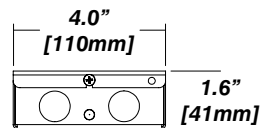
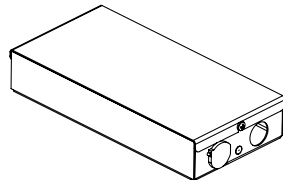

LETO 44 WM LRG

WALL MOUNT LED DOWNLIGHT



Photometrics

Senso's in-house photometric testing ensures that our lighting design can match your needs precisely. Our Goniophotometer and testing lab produces on-demand photometry files based on any specified fixture, including LM-79 Test reports, IES Files, and CRI/CCT measurements. See Sensolighting.com for more information.

**Full photometric Reports and IES files available for every configuration*

Leto 44 Light Distribution

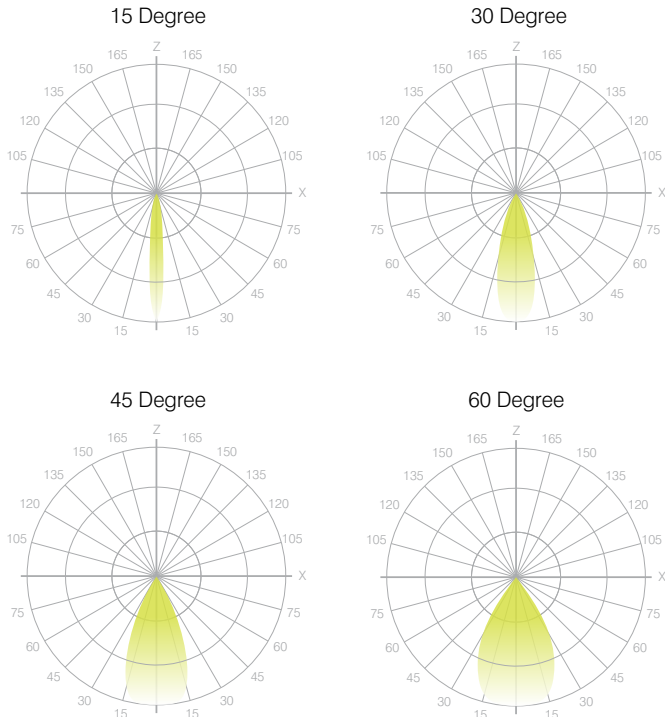

Color Metrics

TM 30-15

Our clients deserve the best information possible about their lighting choices. That's why Senso has invested in the Illuminating Engineering Society (IES) TM 30-15, a new system that measures an LED light source's color rendering properties. Using Senso's state-of-the-art goniophotometer, this method identifies the optimal light source for your project and helps evaluate the trade-offs between efficacy and color rendering. Senso can provide TM 30-15 data for all of our products.

**Full Color Metric Info Available at Sensolighting.com*

LED Module Performance

- Output:** Up to 113 lumen/Watt
- Efficacy:** Color consistency within a 3-MacAdam Ellipse
- CCT:** 2500K - 6500K
- Color Rendering:** 93+ CRI
- Min. R Values:** R⁹ - 60 R^f - 90 R^a - 100

Driver and Power Consumption

- Dimming:** 1% dimming standard with 0.1% option
Casambi wireless control available
- Ripple:** Industry leading Low ripple
- Efficiency:** Power Factor >0.9
Efficiency over 85%
Class 2 output for safety
- Installation:** Remote mounted

Lumen Option	700lm	1000lm	1500lm	2000lm
Fixture Wattage	6.1W	9.1W	14W	19.8W
Delivered Lumen	691lm	1018lm	1513lm	2065lm