

LETO 44 Mini WM UD

WALL MOUNT LED DOWNLIGHT

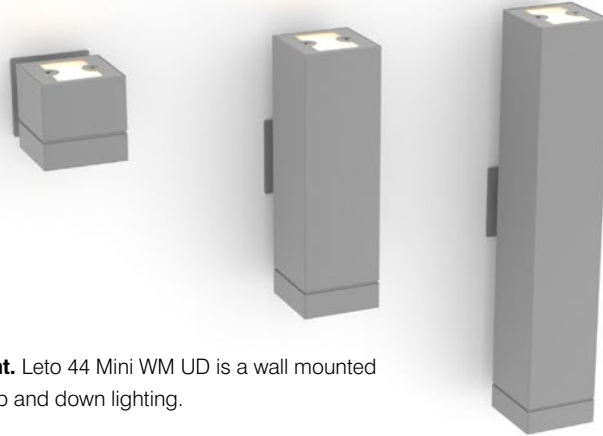

Leto 44 Mini WM UD - Wall Mount Direct/Indirect LED Light. Leto 44 Mini WM UD is a wall mounted cylinder LED fixture designed to provide a space with indirect up and down lighting.

Ordering Code

Fixture	743								
	1	2	3	4	5	6	7	8	9
Driver					--	--			
	1	2	3	4	5	6			

Product Specifications

SAMPLE: Fixture **743 - S - A90 - 617 - 27 - 0505 - 00 - 08 - 01** | Driver **955 - 08 - STD - 120 - A90 - 0505**

1 - Model	2 - Size	3 - CRI/LED	4 - Optic Direct	5 - CCT	6 - Lumen ^{**1/2}
743 · Leto 44 Mini UD Wall Mount	S · Small (73mm) ^{**1} M · Medium (209mm) L · Large (346mm)	A90 · 93+ CRI Accuracy	617 · 17° 624 · 24° 660 · 60° <i>No optic on up light</i>	25 · 2500K 27 · 2700K 30 · 3000K 35 · 3500K 40 · 4000K 65 · 6500K	<i>Direct / Indirect</i> 0505 · 500/500 (9.4W) 1010 · 1000/1000 (20.2W)

7 - Accessory	8 - Body Color	9 - Baffle Color	1 - Canopy Style	2 - Canopy Color
00 · No Accessory DL · Diffusing Film HO · Honeycomb ^{**3} <i>Fixed Diffusing Film on indirect optic</i>	<i>Standard</i> 01 · White 02 · Black 08 · Silver <i>Premium</i> 52 · Mocha 53 · Charcoal 54 · Cerulean 55 · Firebrick BZ · Bronze WN · Warm Nickel AB · Aged Brass XX · RAL	<i>Standard</i> 01 · White 02 · Black 08 · Silver <i>Premium</i> 52 · Mocha 53 · Charcoal 54 · Cerulean 55 · Firebrick BZ · Bronze WN · Warm Nickel AB · Aged Brass XX · RAL	955 · Round Slim 965 · Square Slim 954 · Round Semi-Recessed	<i>Standard</i> 01 · White 02 · Black 08 · Silver <i>Premium</i> 52 · Mocha 53 · Charcoal 54 · Cerulean 55 · Firebrick BZ · Bronze WN · Warm Nickel AB · Aged Brass XX · RAL

3 - Driver	Dim Level	Dim Level	4 - Voltage	5 - CRI/LED	6 - Lumen
STD · Non Dimming ^{**7} LCS · 0 - 10 Volt Protocol ^{**7} DIM · Phase ^{**5/7} ELDOLC · EldoLED 0 - 10 Volt ^{**4}	N/A 1% 1% 0.1%	DALI · Dali Protocol ^{**4} LUTES · Hilume Ecodigital ^{**4} LUT2W · 2 Wire for phase ^{**4/5}	0.1% 1% 1%	120 · 120V 277 · 277V 347 · 347V ^{**4/6}	Same as Fixture Same as Fixture

*1 small limited to 500lm direct/500lm indirect

**2 total wattage of direct and indirect

**3 not available with small size

**4 remote mount driver

**5 120V only

**6 not available with DALI or Lutron drivers

7 Can be junction box mounted with **955 and **965**. See page 2 for details.



LETO 44 Mini WM UD

WALL MOUNT LED DOWNLIGHT



LED Module Performance

- Output:** up to 2000lm
- High Efficacy:** up to 100 lumen/Watt
- Color Options (CCT):** 2500K, 2700K, 3000K, 3500K, 4000K, 6500K
- Color Consistency:** Range within a 3-MacAdam Ellipse
- Color rendering (CRI):** 93+ CRI & 50+ R9 Value

Driver and Power Consumption

- Dimming:** 1% dimming standard with 0.1% option
- Ripple:** Industry leading Low ripple
- Efficiency:** Power Factor >0.9
Efficiency over 85%
Class 2 output for safety

Driver Placement

- **Standard, LCS, and Phase dimming** drivers may be mounted in the junction box.
- Minimum volume required to mount drivers in junction box:
70mm x 40mm x 30mm

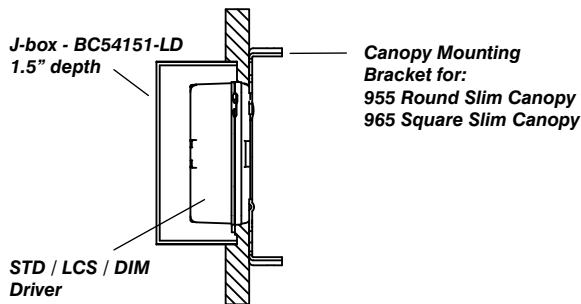

Installation

- Pre-assembled for quick installation
- Low profile against the wall gives a floating appearance

Construction

- Machined aluminum construction
- Powder coated in standard or premium finishes
- Made in Canada

Dimensions

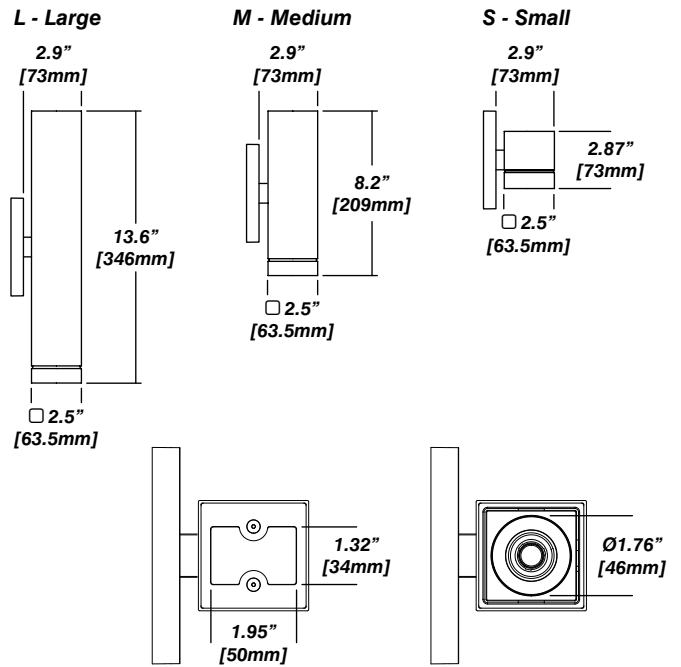

LETO 44 Mini WM UD

WALL MOUNT LED DOWNLIGHT



Accessories

Diffusing Film

Honeycomb



Standard Finishes

01 - White

02 - Black

08 - Silver

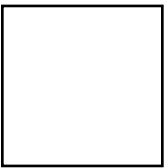

Premium Finishes

55 - Mocha

56 - Charcoal

57 - Cerulean



58 - Firebrick

BZ - Bronze

WN - Warm Nickel



AB - Aged Brass



Canopy

955 - Round Slim

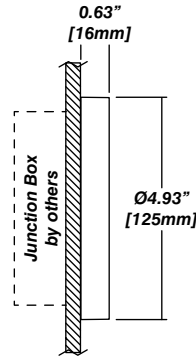

965 - Square Slim

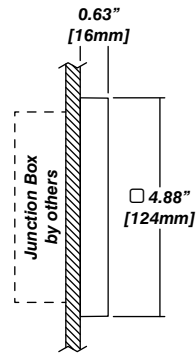

954 - Semi-Recessed + Cylinder Driver Housing

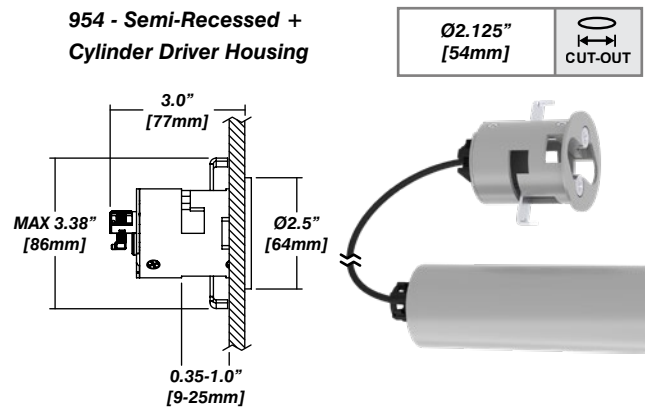

LETO 44 Mini WM UD

WALL MOUNT LED DOWNLIGHT



Senso Driver Housings

910 - Single Remote Driver Housing

- Fits Standard, LCS or DIM drivers
- Galvanized steel enclosure
- Installed in remote location

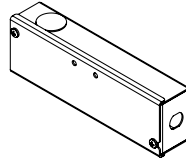

Dimensions

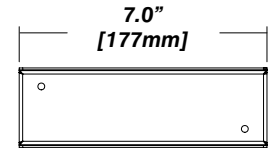
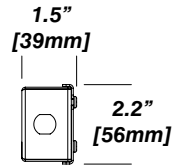

910 - Double Remote Driver Housing

- Fits all drivers
- Galvanized steel enclosure
- Installed in remote location

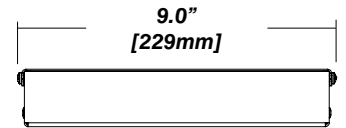
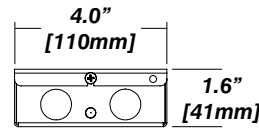
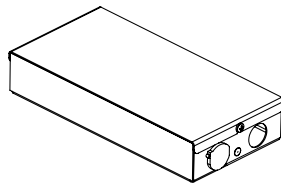

954 - Cylinder Driver Housing

- Supplied standard with every semi-recessed canopy
- Fits Standard, LCS or DIM drivers
- Extruded aluminum enclosure with strain relief to fixture
- Installed in ceiling beside canopy

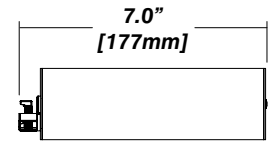
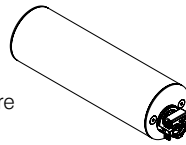

954 Driver Layouts

954 with Cylinder Driver Housing

- Installed in ceiling beside canopy
- Driver mounted inside cylinder
- Dimming control wired from Cylinder Driver Housing

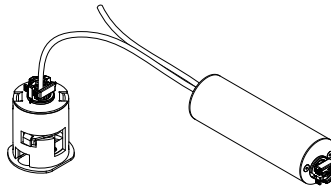

954 with Cylinder Driver Housing

+ 910 Single Driver Housing

- Driver remotely mounted inside 910 housing
- Fed directly to 954 cylinder for DC connections (wire and strain reliefs supplied by others)

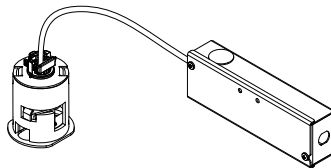

954 with Cylinder Driver Housing

+ 910 Double Driver Housing

- Driver remotely mounted inside 910 housing
- Fed directly to 954 cylinder for DC connections (wire and strain reliefs supplied by others)

