

LETO 11 Mini S

SURFACE MOUNT LED DOWNLIGHT



LETO 11 Mini S - Surface LED Light. Leto 11 Mini S is the surface mount version of the Leto 11 Mini P. Designed as an all purpose light, it's perfect for creating even light throughout your space without distracting from your design.

Ordering Code

Fixture	654								
	1	2	3	4	5	6	7	8	9
Driver					--	--			
	1	2	3	4	5	6			

Product Specifications

SAMPLE: Fixture **654 - S - A90 - 617 - 27 - 07 - 00 - 08 - 01** | Driver **STD - 120 - A90 - 07**

1 - Model	2 - Size	3 - CRI/LED	4 - Optic	5 - CCT	6 - Lumen	7 - Accessory
654 · Leto 11 Mini Surface Mount	S · Small (73mm) M · Medium (209mm) L · Large (346mm)	A90 · 93+ CRI Accuracy	617 · 17° 624 · 24° 660 · 60°	25 · 2500K 27 · 2700K 30 · 3000K 35 · 3500K 40 · 4000K 65 · 6500K	07 · 700 (6.1W) 10 · 1000 (9.1W) 15 · 1500 (14W)	00 · No Accessory DL · Diffusing Film HO · Honeycomb**

8 - Body Color		9 - Baffle Color		1 - Canopy Style	2 - Canopy Color	
<i>Standard</i>	<i>Premium</i>	<i>Standard</i>	<i>Premium</i>	955 · Round Slim* ² 954 · Round Semi-Recessed	<i>Standard</i>	<i>Premium</i>
01 · White 02 · Black 08 · Silver	52 · Mocha 53 · Charcoal 54 · Cerulean 55 · Firebrick BZ · Bronze WN · Warm Nickel AB · Aged Brass XX · RAL	01 · White 02 · Black 08 · Silver	52 · Mocha 53 · Charcoal 54 · Cerulean 55 · Firebrick BZ · Bronze WN · Warm Nickel AB · Aged Brass XX · RAL		01 · White 02 · Black 08 · Silver	52 · Mocha 53 · Charcoal 54 · Cerulean 55 · Firebrick BZ · Bronze WN · Warm Nickel AB · Aged Brass XX · RAL

3 - Driver		Dim Level	Dim Level	4 - Voltage	5 - CRI/LED	6 - Lumen
STD · Non Dimming	N/A	DALI · Dali Protocol* ⁴	0.1%	120 · 120V	Same as Fixture	Same as Fixture
LCS · 0 - 10 Volt Protocol	1%	LUTES · Hilume Ecodigital* ⁴	1%	277 · 277V		
DIM · Phase* ³	1%	LUT2W · 2 Wire for phase* ^{3/5}	1%	347 · 347V* ^{4/5}		
ELDOLC · EldoLED 0 - 10 Volt* ⁴	0.1%					

*1 accessories not available with small size

*2 10mm stem required for Round Slim see page 2 Canopy section

*3 120V only

*4 remote mount

*5 not available with DALI or Lutron drivers



LETO 11 Mini S

SURFACE MOUNT LED DOWNLIGHT



LED Module Performance

- Output:** up to 1500lm
- High Efficacy:** up to 110 lumen/Watt
- Color Options (CCT):** 2500K, 2700K, 3000K, 3500K, 4000K, 6500K
- Color Consistency:** Range within a 3-MacAdam Ellipse
- Color rendering (CRI):** 93+ CRI & 50+ R9 Value

Driver and Power Consumption

- Dimming:** 1% dimming standard with 0.1% option
- Ripple:** Industry leading Low ripple
- Efficiency:** Power Factor >0.9
Efficiency over 85%
Class 2 output for safety

Lumen Option	700lm	1000lm	1500lm
Delivered Lumen	668lm	1002lm	1441lm
Fixture Wattage	6.1W	9.1W	14W

Installation

- Pre-assembled for quick and easy installation
- Flush mount to ceiling for gapless appearance

Construction

- Machined aluminum construction
- High quality, scratch resistant powder coated finish in standard, premium or custom colors
- Made in Canada

Dimensions

L - Large

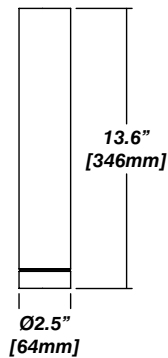

M - Medium

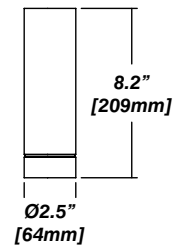

S - Small

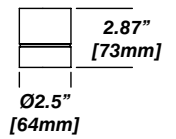

LETO 11 Mini S

SURFACE MOUNT LED DOWNLIGHT

Accessories

Diffusing Film



Honeycomb

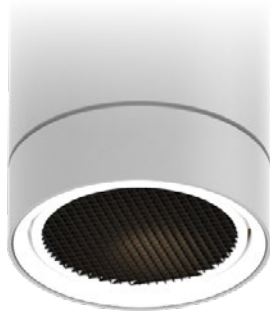

Standard Finishes

01 - White

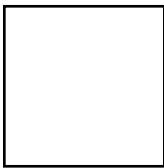

02 - Black

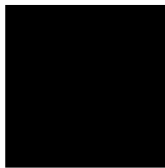

08 - Silver



Premium Finishes

55 - Mocha



56 - Charcoal



57 - Cerulean



58 - Firebrick



BZ - Bronze



WN - Warm Nickel



AB - Aged Brass



Canopy

955 - Round Slim

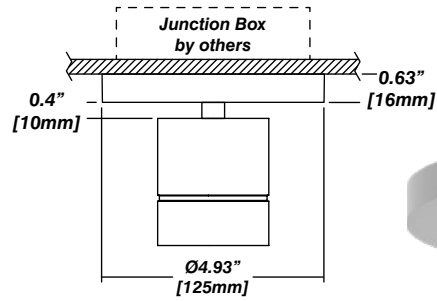

954 - Semi-Recessed + Cylinder Driver Housing

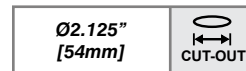
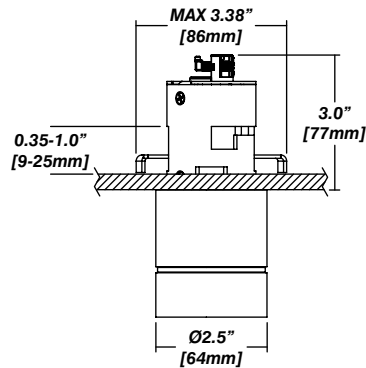

LETO 11 Mini S

SURFACE MOUNT LED DOWNLIGHT

Senso Driver Housings

910 - Single Remote Driver Housing

- Fits Standard, LCS or DIM drivers
- Galvanized steel enclosure
- Installed in remote location

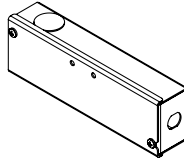

Dimensions

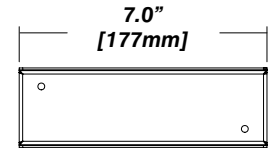
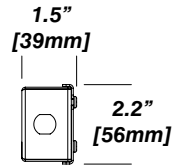

910 - Double Remote Driver Housing

- Fits all drivers
- Galvanized steel enclosure
- Installed in remote location

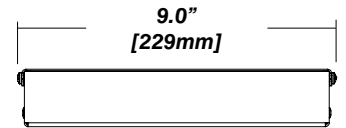
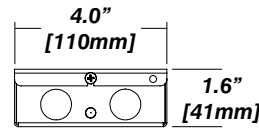
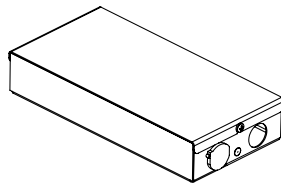

954 - Cylinder Driver Housing

- Supplied standard with every semi-recessed canopy
- Fits Standard, LCS or DIM drivers
- Extruded aluminum enclosure with strain relief to fixture
- Installed in ceiling beside canopy

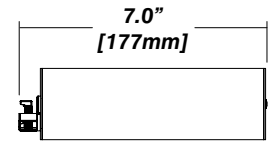
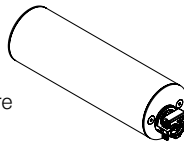

954 Driver Layouts

954 with Cylinder Driver Housing

- Installed in ceiling beside canopy
- Driver mounted inside cylinder
- Dimming control wired from Cylinder Driver Housing

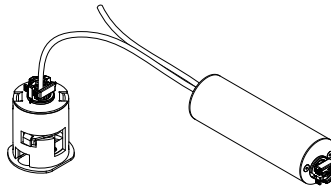

954 with Cylinder Driver Housing

+ 910 Single Driver Housing

- Driver remotely mounted inside 910 housing
- Fed directly to 954 cylinder for DC connections (wire and strain reliefs supplied by others)

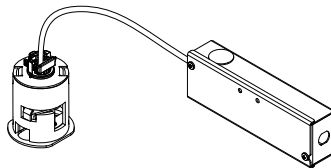

954 with Cylinder Driver Housing

+ 910 Double Driver Housing

- Driver remotely mounted inside 910 housing
- Fed directly to 954 cylinder for DC connections (wire and strain reliefs supplied by others)

