

Features

Kurba Max Vertical is a direct view, high output, energy efficient and flexible LED strip suitable for wet locations capable of vertical/top bends up to 2.5" radius. Built with robust factory made power feeds or joiners, Kurba Max Vertical mounts to a specifically designed aluminum extruded channel. Note: Color temperature of Kurba Max may not exactly match other profiles.

Applications

Outdoor wet location

Operating Voltage

24VDC

Operating Temperature

-40°F to 113°F (-40°C to 45°C)

Average Life

50,000 hours

Dimming

Low voltage dimmer and class 2 dimming power supply required

Approvals

Class 2 wet listed, IP67

Warranty

3 years



Technical Information

Model	KBX-SF-V	CCT INFO / LUMEN MULTIPLIER	
		Color Temperature	Multiplier (ref. -3000K)
LEDs/ft	43	2200K	0.98
Light Output at 3000K	458 lm/ft	2700K	1.01
Average Power Consumption at 4'	5.0 W/ft	3000K	1.00
Ordering Increment	1.97"	3500K	1.08
Maximum Run Length (In Series)	18 ft	4000K	1.04

Constraints

Bend Direction

Bend LED in these positions only to avoid damage

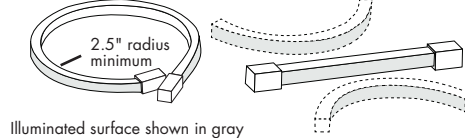

Illuminated surface shown in gray

Prohibited Bends

Twisting or bending LED in these positions will cause damage

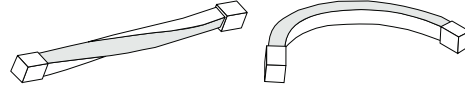

Illuminated surface shown in gray

Note: for horizontal bends refer to Luminii KBM series
Do not make sharp bends near the endcap

Power Feed Locations

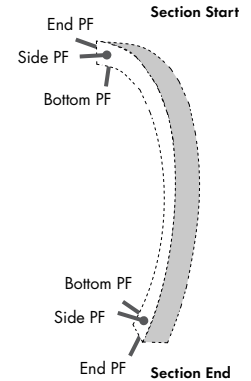

Section Start/End Power Feed Options

Injection Molded End Cap (IEC)

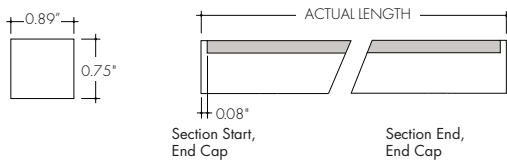

Injection Molded Bottom Power Feed (IBPF)

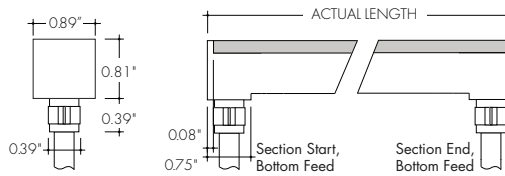

Injection Molded End Power Feed (IEPF)

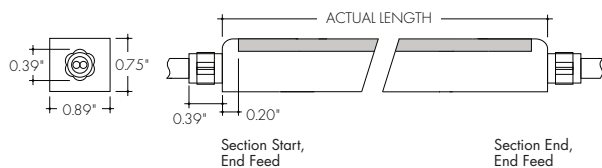

Injection Molded Side Power Feed (ISPF)

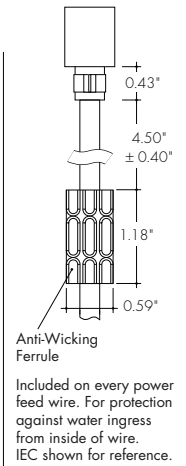
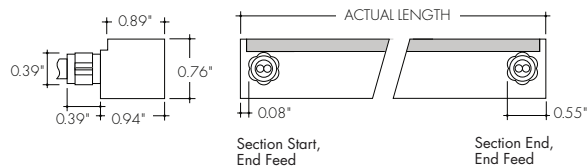

Anti-Wicking Ferrule
Included on every power feed wire. For protection against water ingress from inside of wire. IEC shown for reference.

Ordering Code

MODEL	CCT	SECTION START	SECTION END	ACTUAL LENGTH
KBX-SF-V -Kurba Max, Flat, Vertical/Top Bend	22K-2200K 27K-2700K 30K-3000K 35K-3500K 40K-4000K	IEC-Injection Molded End cap ¹ IEPF-Injection Molded End power feed (9' wire lead) ¹ IBPF-Injection Molded Bottom power feed (9' wire lead) ¹ ISPF-Injection Molded Side power feed (9' wire lead) ^{1,2}	IEC-Injection Molded End cap ¹ IEPF-Injection Molded End power feed (9' wire lead) ¹ IBPF-Injection Molded Bottom power feed (9' wire lead) ¹ ISPF-Injection Molded Side power feed (9' wire lead) ^{1,2}	See Power Consumption table on page 3 for available lengths.

1 - 6-8 weeks lead time. Kurba injected-molded orders are non-cancellable. IEPF, IBPF, ISPF cannot be mixed and matched from Start to End except with IEC.
2 - ISPF Side power feeds selected for both Section Start and End will be located on the same side of the strip.

Mounting Accessories & Optional Connectors

MC-NFS-KBX-F-78

Mounting Channel with Grip, 78"

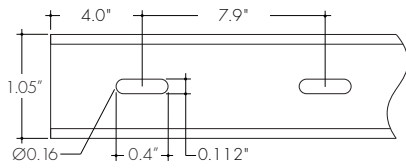
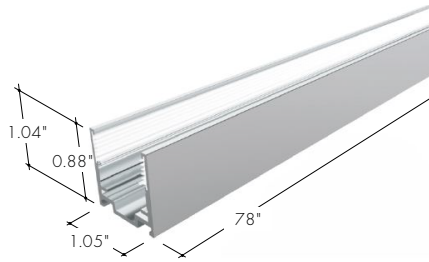

Aluminum mounting channel providing grip. For use with light strip mounted to the ceiling.

MB-KBX-F-ST

Mounting Bracket with Grip, 78"

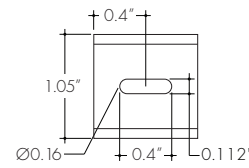
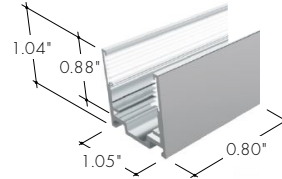

Aluminum mounting bracket providing grip. For use with light strip mounted to the ceiling. 1 recommended every 8 in.

LVSP-WET

Splice Box

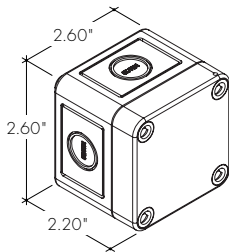

Wet rated, low voltage splice box, gray.

LVSP-WET-CM

Connector

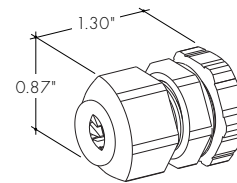

Low voltage splice box wet cable management, gray.

Power Consumption Per Fixture Length

Based on operation with PDCU series of power supplies. Use Acutal Length for Order Code Entry
 Tolerance for Actual Lengths less than 6 ft is +/- 0.2", Actual Lengths between 6 ft and 16 ft is +/- 0.3", and Actual Lengths greater than 16 ft is +/- 0.6"

Nominal Length (in)	Actual Length (in)				Nominal Length (in)	Actual Length (in)				Nominal Length (in)	Actual Length (in)				Nominal Length (in)	Actual Length (in)			
	W	IEPF IEPF	IEC IEPF	IEC IBFP ISPF		W	IEPF IEPF	IEC IEPF	IEC IBFP ISPF		W	IEPF IEPF	IEC IEPF	IEC IBFP ISPF		W	IEPF IEPF	IEC IEPF	IEC IBFP ISPF
2	-	-	-	-	65	27.4	65.4	65.2	65.1	128	53.8	128.4	128.2	128.1	195	81.9	195.3	195.2	195
4	-	-	-	-	67	28.2	67.3	67.2	67.1	130	54.6	130.3	130.2	130.1	197	82.7	197.3	197.1	197
6	2.6	6.3	6.2	6.1	69	29.1	69.3	69.2	69.1	(11 ft) 132	55.5	132.3	132.2	132	199	83.5	199.2	199.1	199
8	3.5	8.3	8.2	8	(6 ft) 71	29.9	71.3	71.1	71	134	56.3	134.3	134.1	134	201	84.3	201.2	201.1	200.9
10	4.3	10.2	10.1	10	73	30.7	73.2	73.1	73	140	58.8	140.2	140	139.9	199	83.5	199.2	199.1	199
(1 ft) 12	5.1	12.2	12.1	12	75	31.5	75.2	75.1	75	142	59.6	142.1	142	141.9	201	84.3	201.2	201.1	200.9
14	5.9	14.2	14.1	13.9	77	32.4	77.2	77.1	76.9	(12 ft) 144	60.4	144.1	144	143.9	(17 ft) 203	85.2	203.2	203	202.9
16	6.8	16.1	16	15.9	79	33.2	79.1	79	78.9	146	61.2	146.1	145.9	145.8	205	86	205.1	205	204.9
18	7.6	18.1	18	17.9	81	34	81.1	81	80.9	148	62.1	148	147.9	147.8	207	86.8	207.1	207	206.9
20	8.4	20.1	20	19.8	(7 ft) 83	34.8	83.1	83	82.8	150	62.9	150	149.9	149.8	209	87.6	209.1	208.9	208.8
22	9.2	22.1	21.9	21.8	85	35.7	85	84.9	84.8	152	63.7	152	151.9	151.7	211	88.5	211	210.9	210.8
(2 ft) 24	10.1	24	23.9	23.8	87	36.5	87	86.9	86.8	154	64.5	153.9	153.8	153.7	213	89.3	213	212.9	212.8
26	10.9	26	25.9	25.8	89	37.3	89	88.9	88.7	(13 ft) 156	65.4	155.9	155.8	155.7	215	90.1	215	214.8	214.7
28	11.7	28	27.8	27.7	91	38.1	91	90.8	90.7	158	66.2	157.9	157.8	157.6	(18 ft) 217	90.9	216.9	216.8	216.7
30	12.5	29.9	29.8	29.7	93	39	92.9	92.8	92.7	160	67	159.8	159.7	159.6					
32	13.4	31.9	31.8	31.7	95	39.8	94.9	94.8	94.6	162	67.8	161.8	161.7	161.6					
34	14.2	33.9	33.7	33.6	(8 ft) 97	40.6	96.9	96.7	96.6	164	68.7	163.8	163.7	163.5					
(3 ft) 36	15	35.8	35.7	35.6	99	41.4	98.8	98.7	98.6	166	69.5	165.8	165.6	165.5					
38	15.8	37.8	37.7	37.6	101	42.3	100.8	100.7	100.6	(14 ft) 168	70.3	167.7	167.6	167.5					
40	16.7	39.8	39.7	39.5	103	43.1	102.8	102.6	102.5	170	71.1	169.7	169.6	169.5					
42	17.5	41.7	41.6	41.5	105	43.9	104.7	104.6	104.5	172	72	171.7	171.5	171.4					
44	18.3	43.7	43.6	43.5	107	44.7	106.7	106.6	106.5	174	72.8	173.6	173.5	173.4					
46	19.1	45.7	45.6	45.4	(9 ft) 109	45.6	108.7	108.5	108.4	176	73.6	175.6	175.5	175.4					
(4 ft) 48	20	47.6	47.5	47.4	111	46.4	110.6	110.5	110.4	178	74.4	177.6	177.4	177.3					
50	20.8	49.6	49.5	49.4	113	47.2	112.6	112.5	112.4	(15 ft) 180	75.3	179.5	179.4	179.3					
52	21.6	51.6	51.5	51.3	115	48	114.6	114.5	114.3	182	76.1	181.5	181.4	181.3					
54	22.4	53.5	53.4	53.3	117	48.9	116.5	116.4	116.3	183	76.9	183.5	183.4	183.2					
56	23.3	55.5	55.4	55.3	119	49.7	118.5	118.4	118.3	185	77.7	185.4	185.3	185.2					
57	24.1	57.5	57.4	57.2	(10 ft) 120	50.5	120.5	120.4	120.2	187	78.6	187.4	187.3	187.2					
(5 ft) 59	24.9	59.5	59.3	59.2	122	51.3	122.4	122.3	122.2	189	79.4	189.4	189.3	189.1					
61	25.7	61.4	61.3	61.2	124	52.2	124.4	124.3	124.2	(16 ft) 191	80.2	191.3	191.2	191.1					
63	26.6	63.4	63.3	63.2	126	53	126.4	126.3	126.1	193	81	193.3	193.2	193.1					

Injection Molded End Cap (IEC)

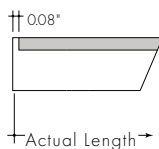

Injection Molded End Power Feed (IEPF)

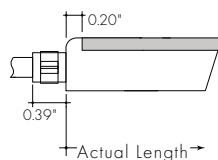

Injection Molded Bottom Power Feed (IBPF)

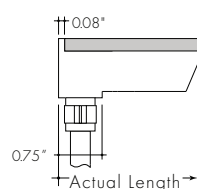

Injection Molded Side Power Feed (ISPF)

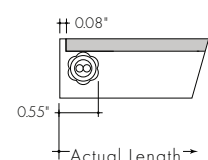

Power Supplies

See Power Supply instructions and spec sheet for wiring information. For a complete list of compatible dimmers, see Compatible Dimming Chart on the Resources page.

Universal Power Supply 1% 120VAC - 277VAC

MODEL	POWER	OUTPUT
PDCU-D - IP20 Dry Series	30 - 30 W 60 - 60 W 96 - 96 W 3X96 - 3X96 W	24 - 24 VDC
PDCU-W - IP66 Wet Series	96 - 96 W 3X96 - 3X96 W	

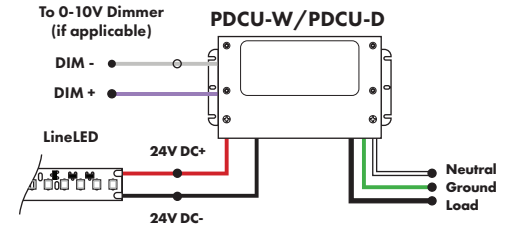

0-10V dims down to 1%, MLV/ELV/TRIAC dims down to 1%.
For a complete list of compatible dimmers, see [Compatible Dimming Chart](#) on the Resources page.

MODELS	PDCU-W 96W	PDCU-W 3X96W	PDCU-D 30W	PDCU-D 60W	PDCU-D 96W	PDCU-D 3X96W
Length	8.66"	11.85"	6.10"	7.93"	8.25"	9.57"
Width	3.73"	4.32"	3.35"	3.35"	4.10"	5.94"
Depth	1.61"	1.81"	1.33"	1.32"	1.56"	1.13"

0-10V Dimming Power Supplies 0.1% 120VAC - 277VAC

MODEL	POWER	OUTPUT	DIMMING
PS010V - 0-10V Power Supply dims down to 0.1%	96 - 96 Watt 3X96 - 3 X 96 Watt	24 - 24 VDC	LIN - Linear LOG - Logarithmic

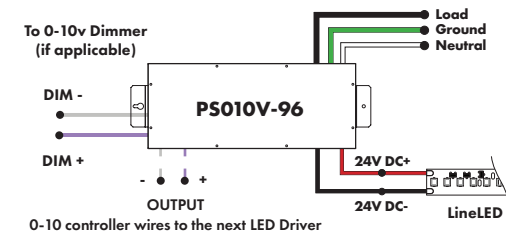

MODELS	96W	3X96
Length	14.40"	15.75"
Width	5.20"	6.62"
Depth	2.60"	4.95"

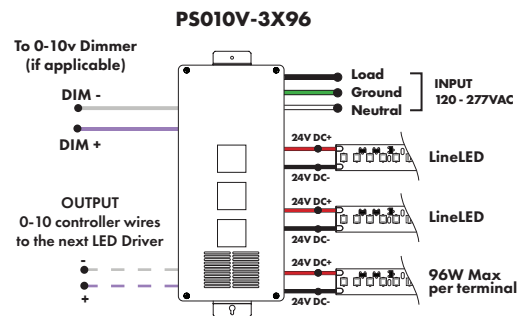

Triac, MLV, & ELV Compatible Dimmers

MODEL	POWER	OUTPUT
PDC - (IP20) Power Supply	96 - 96 Watts	24 - 24 VDC

MODELS	96W
Length	8.25"
Width	4.10"
Depth	1.56"

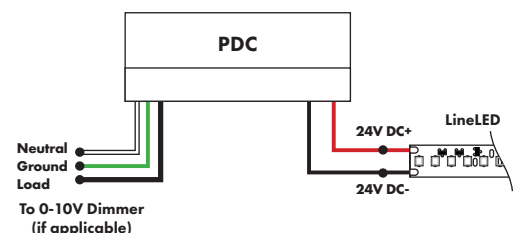

Power Supplies

See Power Supply instructions and spec sheet for wiring information. For a complete list of compatible dimmers, see Compatible Dimming Chart on the Resources page.

DMX Dimming Power Supplies 120VAC - 277VAC

MODEL	POWER	OUTPUT
PSDMX - DMX Power Supply dims down to 0%	96 - 96 Watt 3X96 - 3 X 96 Watt	24 - 24 VDC

Features eldoLED's LINEARdrive configurable dimmable drivers

MODELS	96W	3X96
Length	14.40"	15.75"
Width	5.20"	6.62"
Depth	2.60"	4.95"

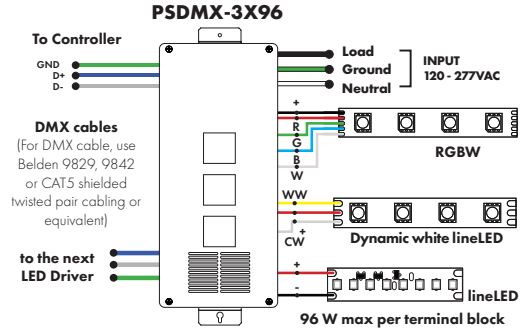
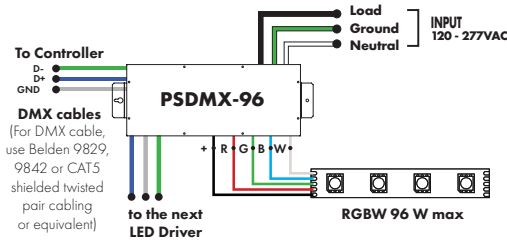

DALI 0% Dimming Power Supplies 120VAC - 277VAC

MODEL	POWER	OUTPUT
PSDALI - DALI Power Supply dims down to 0%	96 - 96 Watt 3X96 - 3 X 96 Watt	24 - 24 VDC

Features eldoLED's LINEARdrive configurable dimmable drivers

Model	96W	3X96
Length	14.40"	15.75"
Width	5.20"	6.62"
Depth	2.60"	4.95"

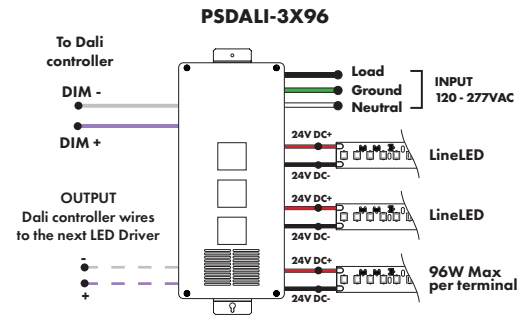
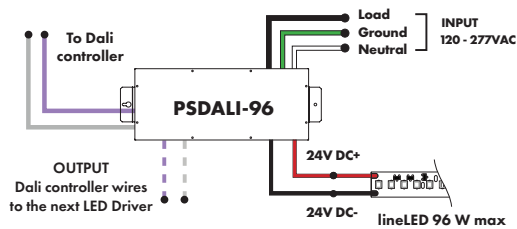

Enlighted Enabled Dimming Power Supplies 120VAC - 277VAC

MODEL	POWER	OUTPUT	DIMMING	LOCATION
PSV - PSV Series	96 - 96 Watt	24 - 24 VDC	ENL - Enlighted Dimming dims down to 0%	D - Damp

Model	96W
Length	14.40"
Width	5.20"
Depth	2.60"

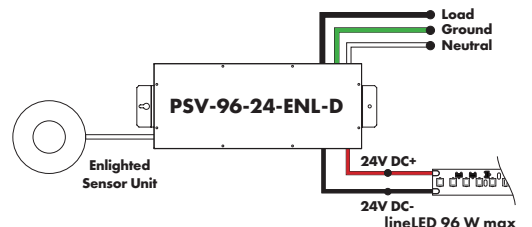

Power Supplies

See Power Supply instructions and spec sheet for wiring information. For a complete list of compatible dimmers, see Compatible Dimming Chart on the Resources page.

Non-Dimming Power Supply 120VAC - 277VAC

MODEL	POWER	OUTPUT	DIMMING	LOCATION
PSV - PSV Series	96 - 96 Watt	24 - 24 VDC	U2ND - Non Dimming	D - Damp

MODELS	96W
Length	14.40"
Width	5.20"
Depth	2.60"

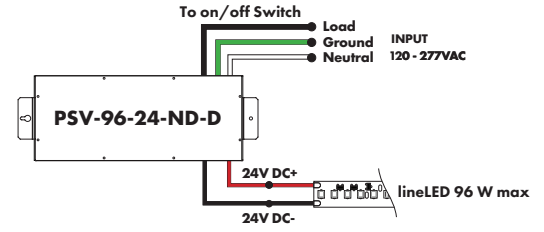

Luminii is a Lutron OEM Advantage Partner

Lutron Power Supplies 1%

MODEL	MODEL
LTEA4U1UKL-CV240	L3DA4U1UKL-CV240
Lutron - HiLume™ 1% 2-wire LED Driver 40W max	HiLume™ 1% EcoSystem Voltage LED driver 40W max

(120V forward phase only)

MODELS	LTEA4U1UKL-CV240	L3DA4U1UKL-CV240
Length	4.89"	4.98"
Width	4.00"	4.00"
Depth	2.62"	2.62"

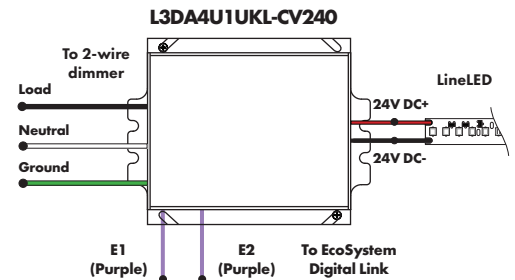
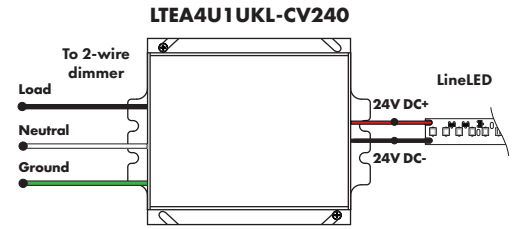

Luminii is a Lutron OEM Advantage Partner

Lutron Power Supplies 0.1%

MODEL
L3D0-96W24V-U
HiLume™ 0.1% EcoSystem Voltage LED Driver with Soft-On, Fade-to-Black™ 96W max

MODELS	L3D0
Length	10.50"
Width	5.50"
Depth	2.00"

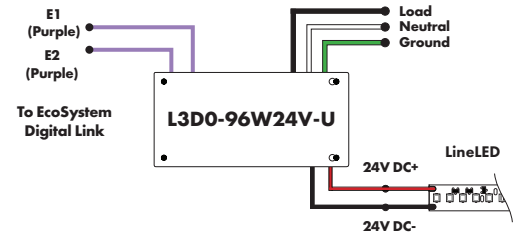

In-Ground Power Supplies

MODEL	POWER	OUTPUT	INPUT
IG - In ground CVE Series	96X2 - 2 X 96 Watt	24 - 24 VDC	Blank - 120 V 277 - 240/277 V
CVE - ELV Dimming DALI - eldoLED Dali dimming			
Both dims down to 0%			

MODELS	Dual Circuit
Length	8.40"
Width	8.30"
Depth	8.10"

