



## Features

Kurba Large Horizontal is a UL676 Pool Rated light strip with a sleek, direct view profile. Suitable for submersion max 6 ft deep and capable of horizontal/side bends up to 2.5" radius. Built with robust factory made power feeds or end caps using UL676 Pool Rated SJTW cabling, Kurba Large Horizontal Pool Rated mounts to a specifically designed thick plastic channel.

### Applications

Pools, Fountains, and Ponds

### Environment

Submersible to max 6ft deep. Water must be <4% salt concentration, <2PPM chlorine, <0.3PPM ozone. Natural hot springs not permissible.

### Operating Voltage

24VDC

### Operating Temperature

-4°F to 113°F (-20°C to 45°C)

### Average Life

50,000 hours

### Dimming

Low voltage dimmer and class 2 dimming power supply required

### Approvals

Class 2, UL676, Pool Rated

### Warranty

3 years



## Technical Information

Model	KBL-SF-H-PL	CCT INFO / LUMEN MULTIPLIER	
		Color Temperature	Multiplier (ref. -3000K)
LEDs/ft	33	2200K	0.98
Light Output at 3000K	178 lm/ft	2400K	1.00
Average Power Consumption at 4'	3.7 W/ft	2700K	1.03
Ordering Increment	2.19"	3000K	1.00
Maximum Run Length (In Series)	25 ft	3500K	1.09
		4000K	1.10

## Constraints

### Bend Direction

Bend LED in these positions only to avoid damage

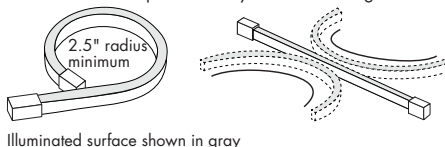

### Prohibited Bends

Twisting or bending LED in these positions will cause damage

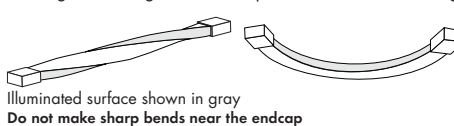

## Power Feed Locations

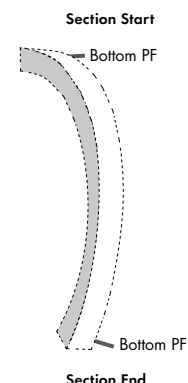

## Section Start/End Power Feed Options

### SJTW Cable Injection Molded End Cap (SEC)

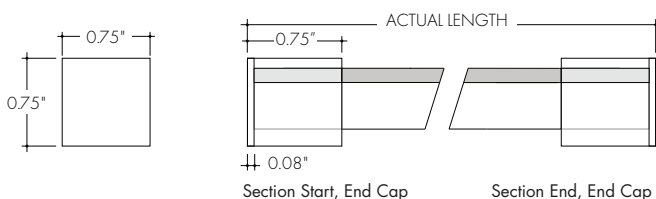

### SJTW Cable Injection Molded Bottom Feed (SBPF)

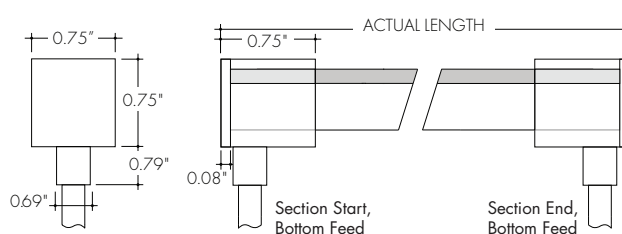

## Ordering Code

MODEL	CCT	SECTION START	SECTION END	ACTUAL LENGTH
KBL-SF-H-PL - Kurba Large, Flat, Horizontal/Side Bend, Pool Rated	22K-2200K 24K-2400K 27K-2700K 30K-3000K 35K-3500K 40K-4000K	SBPF - Pool Rated Black SJTW Cable Injection Molded Bottom Feed (30' wire lead) <sup>1</sup> SEC - Pool Rated Black SJTW Cable Injection Molded End Cap <sup>1</sup>	SBPF - Pool Rated Black SJTW Cable Injection Molded Bottom Feed (30' wire lead) <sup>1</sup> SEC - Pool Rated Black SJTW Cable Injection Molded End Cap <sup>1</sup>	See Power Consumption table on page 3 for available lengths

1 - 6-8 weeks lead time. Kurba injected-molded orders are non-cancellable.

**Mounting Accessories**

---

**MC-NFP-KBL-78**

Thickened Plastic Mounting Channel for underwater application, 78"



**MB-NFP-KBL-ST**

Thickened Plastic Mounting Bracket for underwater application, 1.4"

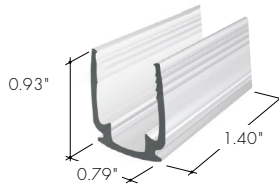

**Power Consumption Per Fixture Length**

Based on operation with PDCU series of power supplies. Use Acutal Length for Order Code Entry  
 Tolerance for Actual Lengths less than 6 ft is +/- 0.2", Actual Lengths between 6 ft and 16 ft is +/- 0.3", and Actual Lengths greater than 16 ft is +/- 0.6"

Nominal Length (in)	Actual Length (in)				Actual Length (in)				Actual Length (in)				Actual Length (in)			
	W	SBPF SBPF	SEC SBPF	Nominal Length (in)	W	SBPF SBPF	SEC SBPF	Nominal Length (in)	W	SBPF SBPF	SEC SBPF	Nominal Length (in)	W	SBPF SBPF	SEC SBPF	Nominal Length (in)
2	-	-	-	79	24.1	<b>78.9</b>	<b>78.9</b>	(13 ft) 155	47.4	<b>155.5</b>	<b>155.5</b>	232	70.7	<b>232</b>	<b>232</b>	
5	-	-	-	81	24.7	<b>81.1</b>	<b>81.1</b>	158	48.1	<b>157.7</b>	<b>157.7</b>	234	71.4	<b>234.2</b>	<b>234.2</b>	
7	2	<b>6.7</b>	<b>6.7</b>	(7 ft) 83	25.4	<b>83.3</b>	<b>83.3</b>	160	48.7	<b>159.8</b>	<b>159.8</b>	236	72.1	<b>236.4</b>	<b>236.4</b>	
9	2.7	<b>8.9</b>	<b>8.9</b>	85	26.1	<b>85.5</b>	<b>85.5</b>	162	49.4	<b>162</b>	<b>162</b>	239	72.7	<b>238.6</b>	<b>238.6</b>	
(1 ft) 11	3.4	<b>11.1</b>	<b>11.1</b>	88	26.7	<b>87.7</b>	<b>87.7</b>	164	50.1	<b>164.2</b>	<b>164.2</b>	(20 ft) 241	73.4	<b>240.8</b>	<b>240.8</b>	
13	4.1	<b>13.3</b>	<b>13.3</b>	90	27.4	<b>89.8</b>	<b>89.8</b>	166	50.7	<b>166.4</b>	<b>166.4</b>	243	74.1	<b>243</b>	<b>243</b>	
15	4.7	<b>15.5</b>	<b>15.5</b>	92	28.1	<b>92</b>	<b>92</b>	(14 ft) 169	51.4	<b>168.6</b>	<b>168.6</b>	245	74.7	<b>245.1</b>	<b>245.1</b>	
18	5.4	<b>17.7</b>	<b>17.7</b>	94	28.7	<b>94.2</b>	<b>94.2</b>	171	52.1	<b>170.8</b>	<b>170.8</b>	247	75.4	<b>247.3</b>	<b>247.3</b>	
20	6.1	<b>19.8</b>	<b>19.8</b>	(8 ft) 96	29.4	<b>96.4</b>	<b>96.4</b>	173	52.7	<b>173</b>	<b>173</b>	250	76.1	<b>249.5</b>	<b>249.5</b>	
22	6.7	<b>22</b>	<b>22</b>	99	30.1	<b>98.6</b>	<b>98.6</b>	175	53.4	<b>175.2</b>	<b>175.2</b>	(21 ft) 252	76.7	<b>251.7</b>	<b>251.7</b>	
(2 ft) 24	7.4	<b>24.2</b>	<b>24.2</b>	101	30.7	<b>100.8</b>	<b>100.8</b>	177	54.1	<b>177.3</b>	<b>177.3</b>	254	77.4	<b>253.9</b>	<b>253.9</b>	
26	8.1	<b>26.4</b>	<b>26.4</b>	103	31.4	<b>103</b>	<b>103</b>	(15 ft) 180	54.7	<b>179.5</b>	<b>179.5</b>	256	78.1	<b>256.1</b>	<b>256.1</b>	
29	8.7	<b>28.6</b>	<b>28.6</b>	105	32.1	<b>105.2</b>	<b>105.2</b>	182	55.4	<b>181.7</b>	<b>181.7</b>	258	78.7	<b>258.3</b>	<b>258.3</b>	
31	9.4	<b>30.8</b>	<b>30.8</b>	(9 ft) 107	32.7	<b>107.3</b>	<b>107.3</b>	184	56.1	<b>183.9</b>	<b>183.9</b>	260	79.4	<b>260.5</b>	<b>260.5</b>	
33	10.1	<b>33</b>	<b>33</b>	110	33.4	<b>109.5</b>	<b>109.5</b>	186	56.7	<b>186.1</b>	<b>186.1</b>	263	80.1	<b>262.6</b>	<b>262.6</b>	
(3 ft) 35	10.7	<b>35.2</b>	<b>35.2</b>	112	34.1	<b>111.7</b>	<b>111.7</b>	188	57.4	<b>188.3</b>	<b>188.3</b>	(22 ft) 265	80.7	<b>264.8</b>	<b>264.8</b>	
37	11.4	<b>37.3</b>	<b>37.3</b>	114	34.7	<b>113.9</b>	<b>113.9</b>	190	58.1	<b>190.5</b>	<b>190.5</b>	267	81.4	<b>267</b>	<b>267</b>	
40	12.1	<b>39.5</b>	<b>39.5</b>	116	35.4	<b>116.1</b>	<b>116.1</b>	(16 ft) 193	58.7	<b>192.7</b>	<b>192.7</b>	269	82.1	<b>269.2</b>	<b>269.2</b>	
42	12.7	<b>41.7</b>	<b>41.7</b>	118	36.1	<b>118.3</b>	<b>118.3</b>	195	59.4	<b>194.8</b>	<b>194.8</b>	271	82.7	<b>271.4</b>	<b>271.4</b>	
44	13.4	<b>43.9</b>	<b>43.9</b>	(10 ft) 120	36.7	<b>120.5</b>	<b>120.5</b>	197	60.1	<b>197</b>	<b>197</b>	274	83.4	<b>273.6</b>	<b>273.6</b>	
46	14.1	<b>46.1</b>	<b>46.1</b>	123	37.4	<b>122.7</b>	<b>122.7</b>	199	60.7	<b>199.2</b>	<b>199.2</b>	(23 ft) 276	84.1	<b>275.8</b>	<b>275.8</b>	
(4 ft) 48	14.7	<b>48.3</b>	<b>48.3</b>	125	38.1	<b>124.8</b>	<b>124.8</b>	201	61.4	<b>201.4</b>	<b>201.4</b>	278	84.7	<b>278</b>	<b>278</b>	
50	15.4	<b>50.5</b>	<b>50.5</b>	127	38.7	<b>127</b>	<b>127</b>	(17 ft) 204	62.1	<b>203.6</b>	<b>203.6</b>	280	85.4	<b>280.1</b>	<b>280.1</b>	
53	16.1	<b>52.7</b>	<b>52.7</b>	129	39.4	<b>129.2</b>	<b>129.2</b>	206	62.7	<b>205.8</b>	<b>205.8</b>	282	86.1	<b>282.3</b>	<b>282.3</b>	
55	16.7	<b>54.8</b>	<b>54.8</b>	(11 ft) 131	40.1	<b>131.4</b>	<b>131.4</b>	208	63.4	<b>208</b>	<b>208</b>	285	86.7	<b>284.5</b>	<b>284.5</b>	
57	17.4	<b>57</b>	<b>57</b>	134	40.7	<b>133.6</b>	<b>133.6</b>	210	64.1	<b>210.2</b>	<b>210.2</b>	287	87.4	<b>286.7</b>	<b>286.7</b>	
(5 ft) 59	18.1	<b>59.2</b>	<b>59.2</b>	136	41.4	<b>135.8</b>	<b>135.8</b>	212	64.7	<b>212.3</b>	<b>212.3</b>	(24 ft) 289	88.1	<b>288.9</b>	<b>288.9</b>	
61	18.7	<b>61.4</b>	<b>61.4</b>	138	42.1	<b>138</b>	<b>138</b>	215	65.4	<b>214.5</b>	<b>214.5</b>	291	88.7	<b>291.1</b>	<b>291.1</b>	
64	19.4	<b>63.6</b>	<b>63.6</b>	140	42.7	<b>140.2</b>	<b>140.2</b>	(18 ft) 217	66.1	<b>216.7</b>	<b>216.7</b>	293	89.4	<b>293.3</b>	<b>293.3</b>	
66	20.1	<b>65.8</b>	<b>65.8</b>	142	43.4	<b>142.3</b>	<b>142.3</b>	219	66.7	<b>218.9</b>	<b>218.9</b>	295	90.1	<b>295.5</b>	<b>295.5</b>	
68	20.7	<b>68</b>	<b>68</b>	(12 ft) 145	44.1	<b>144.5</b>	<b>144.5</b>	221	67.4	<b>221.1</b>	<b>221.1</b>	298	90.7	<b>297.6</b>	<b>297.6</b>	
70	21.4	<b>70.2</b>	<b>70.2</b>	147	44.7	<b>146.7</b>	<b>146.7</b>	223	68.1	<b>223.3</b>	<b>223.3</b>	(25 ft) 300	91.4	<b>299.8</b>	<b>299.8</b>	
(6 ft) 72	22.1	<b>72.3</b>	<b>72.3</b>	149	45.4	<b>148.9</b>	<b>148.9</b>	225	68.7	<b>225.5</b>	<b>225.5</b>					
75	22.7	<b>74.5</b>	<b>74.5</b>	151	46.1	<b>151.1</b>	<b>151.1</b>	(19 ft) 228	69.4	<b>227.6</b>	<b>227.6</b>					
77	23.4	<b>76.7</b>	<b>76.7</b>	153	46.7	<b>153.3</b>	<b>153.3</b>	230	70.1	<b>229.8</b>	<b>229.8</b>					

SJTW Cable Injection Molded End Cap (SEC)

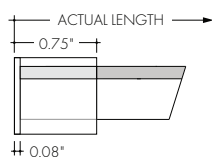

SJTW Cable Injection Molded Bottom Feed (SBPF)

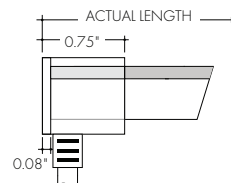

**Power Supplies**

See Power Supply instructions and spec sheet for wiring information. For a complete list of compatible dimmers, see Compatible Dimming Chart on the Resources page.

**Universal Power Supply 1% 120VAC - 277VAC**

MODEL	POWER	OUTPUT
PDCU-D - IP20 Dry Series	30 - 30 W 60 - 60 W 96 - 96 W 3X96 - 3X96 W	24 - 24 VDC
PDCU-W - IP66 Wet Series	96 - 96 W 3X96 - 3X96 W	

0-10V dims down to 1%, MLV/ELV/TRIAC dims down to 1%.  
For a complete list of compatible dimmers, see [Compatible Dimming Chart](#) on the Resources page.

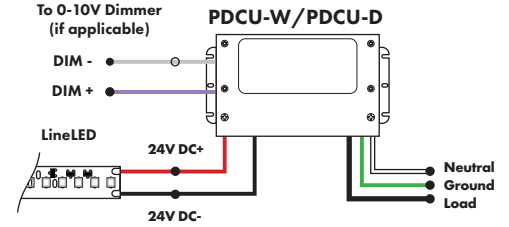

MODELS	PDCU-W 96W	PDCU-W 3X96W	PDCU-D 30W	PDCU-D 60W	PDCU-D 96W	PDCU-D 3X96W
<b>Length</b>	8.66"	11.85"	6.10"	7.93"	8.25"	9.57"
<b>Width</b>	3.73"	4.32"	3.35"	3.35"	4.10"	5.94"
<b>Depth</b>	1.61"	1.81"	1.33"	1.32"	1.56"	1.13"

**0-10V Dimming Power Supplies 0.1% 120VAC - 277VAC**

MODEL	POWER	OUTPUT	DIMMING
PS010V - 0-10V Power Supply dims down to 0.1%	96 - 96 Watt 3X96 - 3 X 96 Watt	24 - 24 VDC	LIN - Linear LOG - Logarithmic

MODELS	96W	3X96
<b>Length</b>	14.40"	15.75"
<b>Width</b>	5.20"	6.62"
<b>Depth</b>	2.60"	4.95"

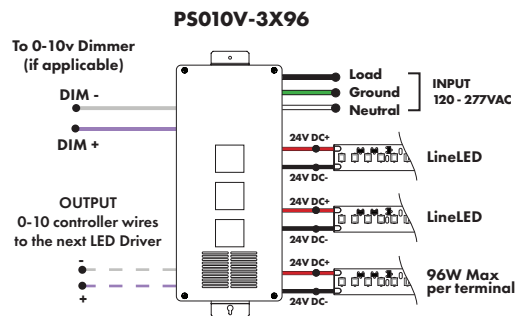
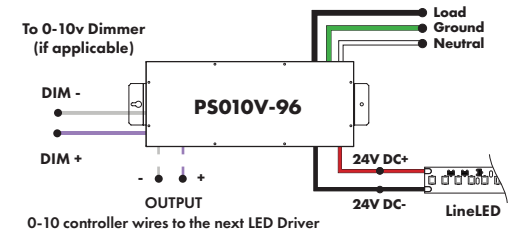

**Triac, MLV, ELV, & PWM Compatible Dimmers**

MODEL	POWER	OUTPUT
PDC - (IP20) Power Supply	96 - 96 Watts	24 - 24 VDC

MODELS	96W
<b>Length</b>	8.25"
<b>Width</b>	4.10"
<b>Depth</b>	1.56"

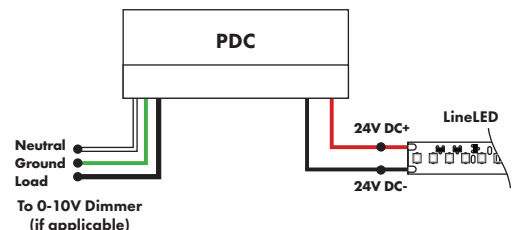

## Power Supplies

See Power Supply instructions and spec sheet for wiring information. For a complete list of compatible dimmers, see Compatible Dimming Chart on the Resources page.

### DMX Dimming Power Supplies 120VAC - 277VAC

MODEL	POWER	OUTPUT
PSDMX - DMX Power Supply dims down to 0%	96 - 96 Watt 3X96 - 3 X 96 Watt	24 - 24 VDC

Features eldoLED's LINEARdrive configurable dimmable drivers

MODELS	96W	3X96
<b>Length</b>	14.40"	15.75"
<b>Width</b>	5.20"	6.62"
<b>Depth</b>	2.60"	4.95"

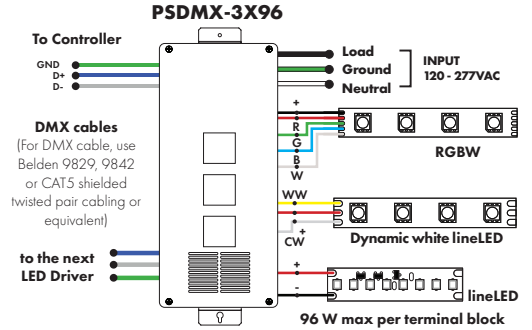
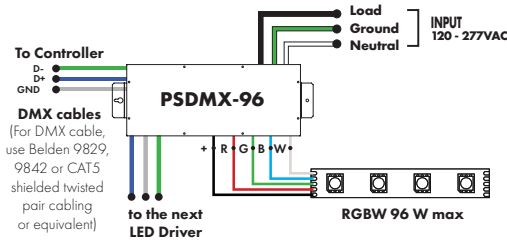

### DALI 0% Dimming Power Supplies 120VAC - 277VAC

MODEL	POWER	OUTPUT
PSDALI - DALI Power Supply dims down to 0%	96 - 96 Watt 3X96 - 3 X 96 Watt	24 - 24 VDC

Features eldoLED's LINEARdrive configurable dimmable drivers

Model	96W	3X96
<b>Length</b>	14.40"	15.75"
<b>Width</b>	5.20"	6.62"
<b>Depth</b>	2.60"	4.95"

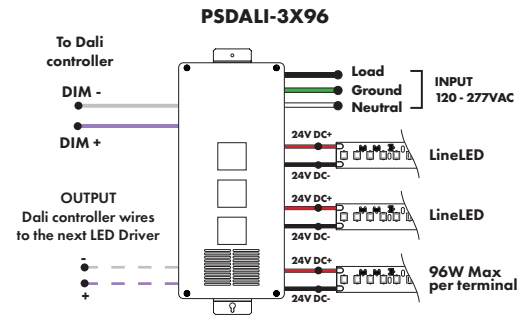
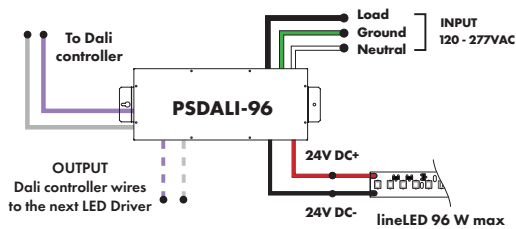

### Enlighted Enabled Dimming Power Supplies 120VAC - 277VAC

MODEL	POWER	OUTPUT	DIMMING	LOCATION
PSV - PSV Series	96 - 96 Watt	24 - 24 VDC	ENL - Enlighted Dimming dims down to 0%	D - Damp

Model	96W
<b>Length</b>	14.40"
<b>Width</b>	5.20"
<b>Depth</b>	2.60"

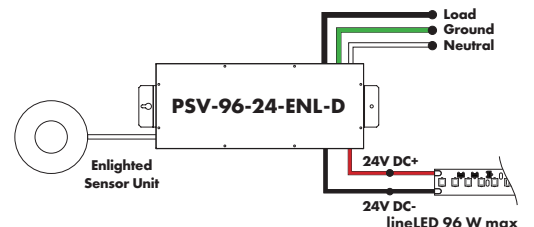

## Power Supplies

See Power Supply instructions and spec sheet for wiring information. For a complete list of compatible dimmers, see Compatible Dimming Chart on the Resources page.

### Non-Dimming Power Supply 120VAC - 277VAC

MODEL	POWER	OUTPUT	DIMMING	LOCATION
PSV - PSV Series	96 - 96 Watt	24 - 24 VDC	U2ND - Non Dimming	D - Damp

MODELS	96W
<b>Length</b>	14.40"
<b>Width</b>	5.20"
<b>Depth</b>	2.60"

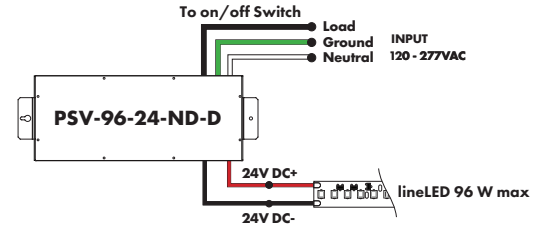

Luminii is a Lutron OEM Advantage Partner

### Lutron Power Supplies 1%

MODEL	MODEL
<b>LTEA4U1UKL-CV240</b>	<b>L3DA4U1UKL-CV240</b>
Lutron - HiLume™ 1% 2-wire LED Driver 40W max	HiLume™ 1% EcoSystem Voltage LED driver 40W max

(120V forward phase only)

MODELS	LTEA4U1UKL-CV240	L3DA4U1UKL-CV240
<b>Length</b>	4.89"	4.98"
<b>Width</b>	4.00"	4.00"
<b>Depth</b>	2.62"	2.62"

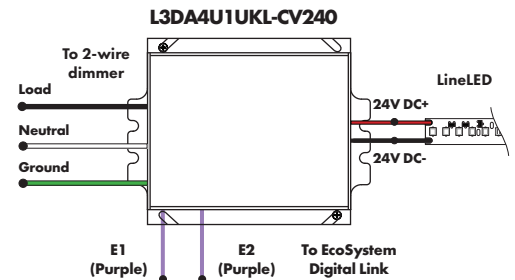
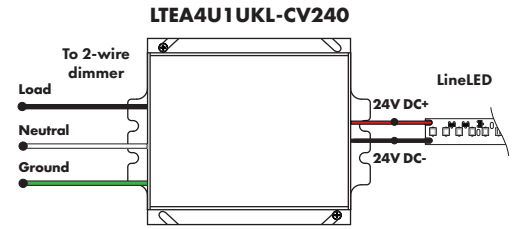

Luminii is a Lutron OEM Advantage Partner

### Lutron Power Supplies 0.1%

MODEL
<b>L3D0-96W24V-U</b>
HiLume™ 0.1% EcoSystem Voltage LED Driver with Soft-On, Fade-to-Black™ 96W max

MODELS	L3D0
<b>Length</b>	10.50"
<b>Width</b>	5.50"
<b>Depth</b>	2.00"

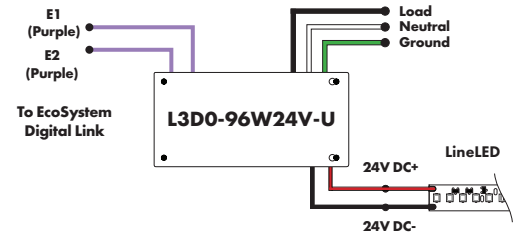

### In-Ground Power Supplies

MODEL	POWER	OUTPUT	INPUT
IG - In ground CVE Series	96X2 - 2 X 96 Watt	24 - 24 VDC	Blank - 120 V 277 - 240/277 V
CVE - ELV Dimming DALI - eldoLED Dali dimming			
Both dims down to 0%			

MODELS	Dual Circuit
<b>Length</b>	8.40"
<b>Width</b>	8.30"
<b>Depth</b>	8.10"

