

**Features**

The KRS Channel is a linear aluminum extrusion that has been designed to fit many recess-mount LED lighting needs. The discrete profile and neutral finish allow for the perfect fit in multiple mounting surfaces for any application. Channels come with specified Mounting Clips and End Caps.

**Finish**

Silver anodized, White, Black, Bronze

**Mounting**

Multiple mounting Clips

**Diffuser Lens**

Polycarbonate, snap-in-place, UV resistant



**Product Dimensions**

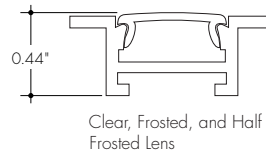
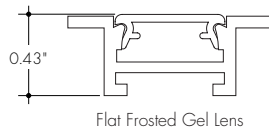
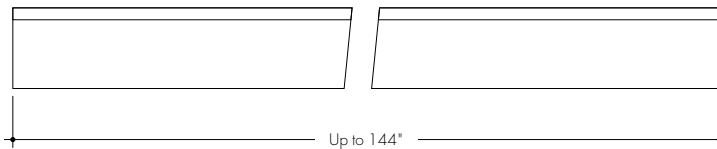
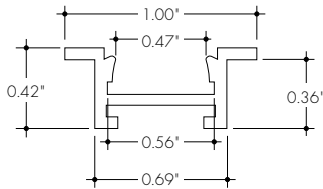

**INCLUDED MOUNTING ACCESSORIES**

EXTRUSION LENGTH	HARD SURFACE	GYPSUM SURFACE	ENDCAP PAIR
48"	2	6	1
72"	3	6	1
96"	3	8	1
144"	4	10	1

Each pair of endcaps includes 2x H3 (no wire feed hole) end caps where applicable. Additional endcaps and mounting clips are available for purchase.

**Ordering code**

MODEL	LENGTH	LENS	MOUNTING <sup>2</sup>	FINISH <sup>4</sup>
KRSC - KRS Channel <sup>1</sup>	48 - 48" 72 - 72" 96 - 96" <sup>3</sup> 144 - 144" <sup>3</sup>	C - Clear F - Frosted HF - Half Frosted FF - Flat Frosted Gel	HS - Hard Surface Mounting Bracket GS - Gypsum Surface Mounting Bracket	SA - Silver anodized WH - White BK - Black BZ - Bronze

1 - End Caps are included with channel, two of H3(no hole). Order additional End Caps as necessary.  
 2 - Mounting Clips are included with channel. Refer to chart above for provided mounting clip quantities. Order additional Mounting Clips as necessary.  
 3 - For Channels and Lenses over 90", incremental shipping charges will apply.  
 4 - Non SA finishes may have extended lead times. Custom RALs are available, please consult Inside Sales with specific request.

All Channels come with a specified set of Mounting Clips and End Caps, see Ordering Code for details. Order additional Mounting Clips and End Caps as necessary.

### Mounting Brackets

**MB-KRMSC-G**  
Stainless Steel Gypsum Surface Mounting Bracket  
**-GS**

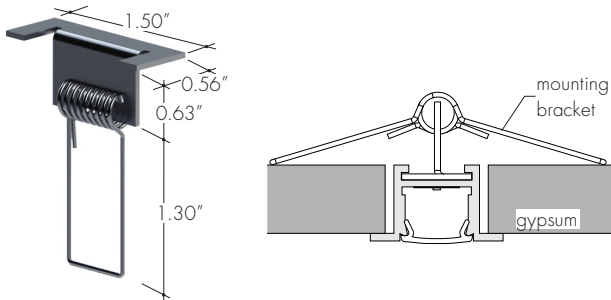

**MB-KRMSC-H**  
Stainless Steel Hard Surface Mounting Bracket  
**-HS**

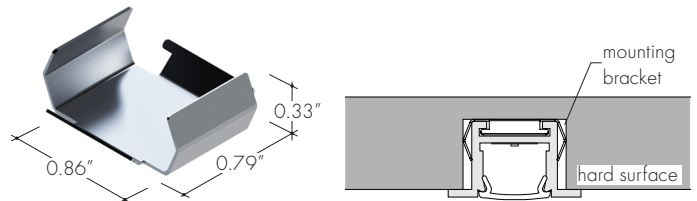

### End Caps

**EC-KRSC-F-H3-XX**  
Silver Anodized End Cap

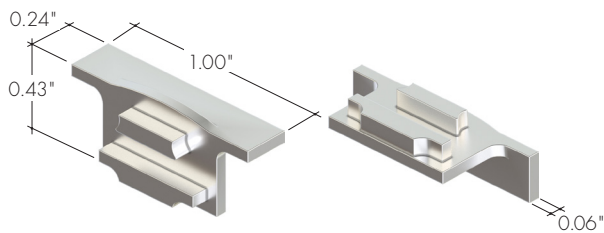

XX	Color
SA	Silver Anodized
WH	White
BK	Black
BZ	Bronze

