



The K45V Channel is a linear aluminum extrusion that has been designed to fit many LED lighting needs and specifically corner applications. Multiple configuration options allow for great flexibility in any installation. Substantial aluminum mass in profile provides excellent heat sink for high power LEDs. K45V Channel is available with frosted lens. Extrusion and lenses are field cuttable. Mounting bracket and end-caps can be ordered separately (page 2).

Finish

- Silver anodized
- White

Mounting

Mounting bracket

Diffuser lens

- Polycarbonate
- Snap-in-place,
- UV resistant



Product dimensions

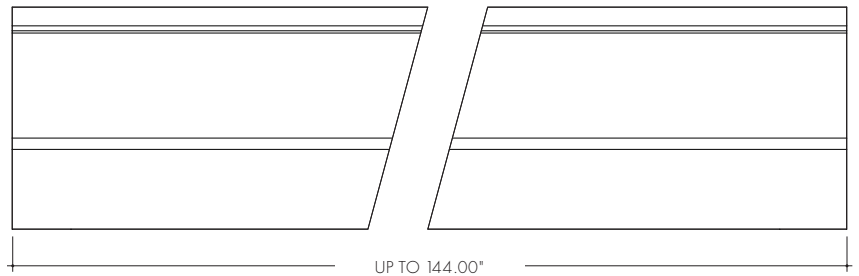
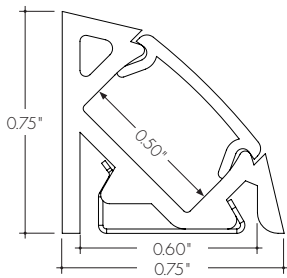

Lens	
Actual Length	48", 72", 96", & 144"
Available Lens	<ul style="list-style-type: none"> • Clear • Frosted • Half Frosted • Clear 10° beam angle • Flat Frosted Gel

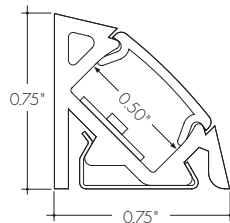

Clear, Frosted, & Half Frosted lens

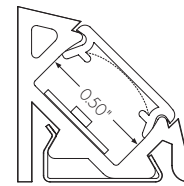

Flat Frosted Gel Lens

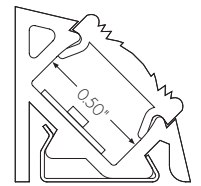

Clear 10° Lens

Ordering code

MODEL	LENGTH	LENS	FINISH
K45VC	48	C	SA
K45VC - K45V Channel	48 - 48" 72 - 72" 96 - 96" 144 - 144"	C - Clear F - Frosted HF - Half Frosted C10 - Clear 10° beam angle FFG - Flat Frosted Gel	SA - Silver anodized WH - White

All accessories sold separately.

Mounting Bracket

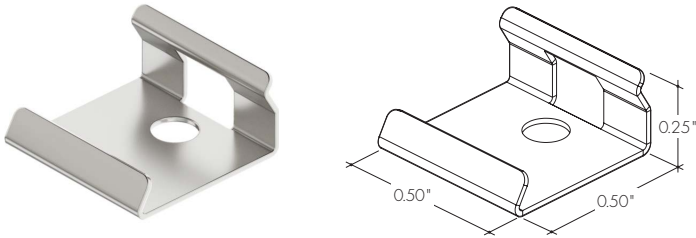

ORDERING CODE

MB-K45VC-SS

MB-K45VC-SS - Stainles steel screw-in mounting bracket

End Caps

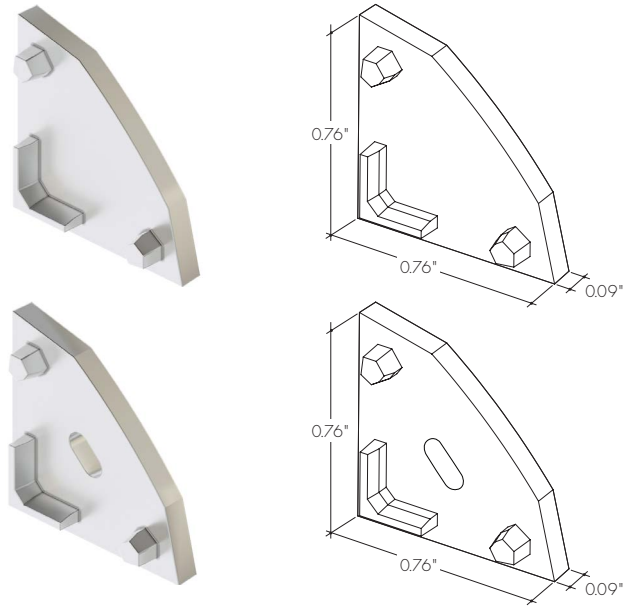

ORDERING CODE

EC - **K45VC** - **H3** - **SA**

EC-K45VC - K45V Channel End Cap

H3 - w/o hole
H4 - w/hole

SA - Silver Anodized
WH - White

